



**FIBREGY**

# Introduction to **FIBREGY** project

Prof. Julio García-Espinosa

CIMNE

E. [julio@cimne.upc.edu](mailto:julio@cimne.upc.edu)



# FIBREGY

## **FIBREGY**

*Development, engineering, production and life-cycle management of improved FIBRE-based material solutions for structure and functional components of large offshore wind enerGY and tidal power platform*

**CALL:** H2020-LC-NMBP-31-2020

**INTRUMENT:** Innovation Action

**STARTING DATE:** 01/01/2021

**PROJECT DURATION:** 36 mos.

## **SOME FACTS**

**8.0 M€**

TOTAL BUDGET

**6.5 M€**

MAX GRANT AMOUNT

**12** PARTNERS FROM  
7 COUNTRIES

**> 40**

RESEARCHERS

**> 900 PM**

TOTAL EFFORT

**80%**

OF TOTAL EFFORT DEVOTED TO  
ENGINEERING, DEVELOPMENT,  
BUILDING AND TESTING

Participant Organisation Name	Short name	Country
Centre Internacional de Mètodes Numèrics en Enginyeria	CIMNE	SP
Bureau Veritas	BV	FR
EnerOcean S.L.	ENEROCEAN	SP
IXBLUE	IXBLUE	FR
University of Limerick - Irish Centre for Composites Research	ULIM	IE
Compass Ingeniería y Sistemas	COMPASSIS	SP
Técnicas y Servicios de Ingeniería	TSI	SP
INEGI - Instituto de Ciência e Inovação em Engenharia Mecânica e Engenharia Industrial	INEGI	PT
Tidetec AS	TIDETEC	NO
Curso Magenta	CORSO	FR
TUCO Yacht Vaerft APS	TUCO	DK
AVK – Industrievereinigung Verstärkte Kunststoffe e.V.	AVK	GE



- The open sea is a very aggressive environment, which largely affect the maintenance costs of the offshore installations.
- A massive amount of steel goes into offshore assets, which explains why corrosion accounts for approximately 60% of offshore maintenance costs.
- Despite the convenient immunity to corrosion and superior fatigue performance of FRP, none of the structures of the Floating Offshore Wind Turbine concepts that have reached a high TRL are based on composites.
- If we look at the field of tidal power generators, the use of FRP materials for rotor blades is common but, with rare exceptions , the platform structure - the major cost item- is made of steel.
- Reasons: lack of design and assessment (certification) guidelines, different technology gaps that have to be filled to demonstrate the full feasibility of using FRP materials in the offshore industry, prove a significant lower life cycle reduction.

**The overall objective of the FIBREGY project is to enable the extensive use of FRP materials in the structure of the next generation of large Offshore Wind and Tidal Power platforms. In order to achieve this objective, the project will develop, qualify and audit innovative FRP materials for offshore applications, elaborate new design procedures and guidelines, generate efficient production, inspection and monitoring methodologies, and validate and demonstrate advanced software analysis tools. Finally, the different developed technologies will be demonstrated by using advanced simulation techniques and building large and real-scale prototypes.**

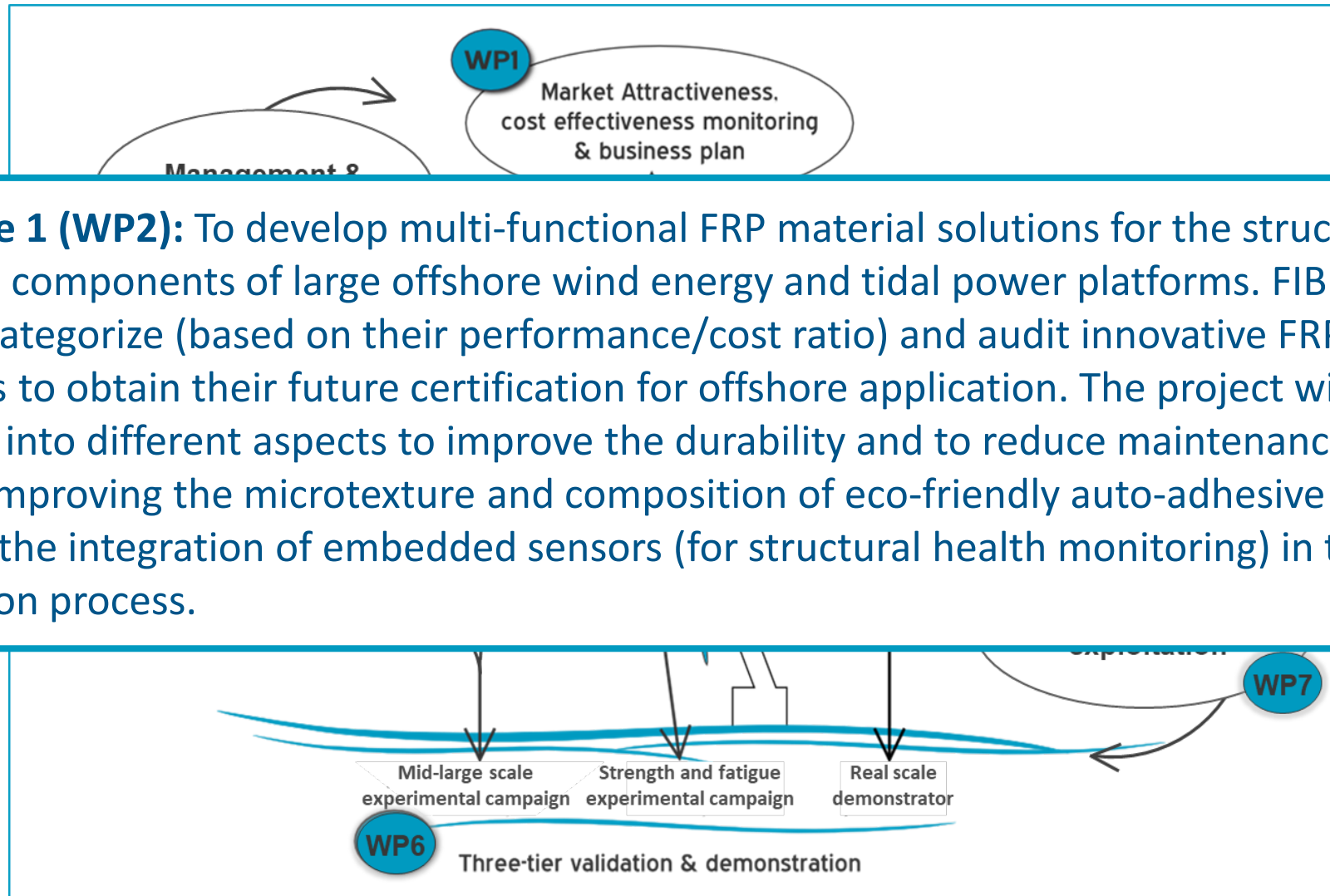

**Objective 1 (WP2):** To develop multi-functional FRP material solutions for the structure and the main components of large offshore wind energy and tidal power platforms. FIBREGY will qualify, categorize (based on their performance/cost ratio) and audit innovative FRP materials to obtain their future certification for offshore application. The project will also research into different aspects to improve the durability and to reduce maintenance needs, such as improving the microtexture and composition of eco-friendly auto-adhesive paint films, or the integration of embedded sensors (for structural health monitoring) in the production process.

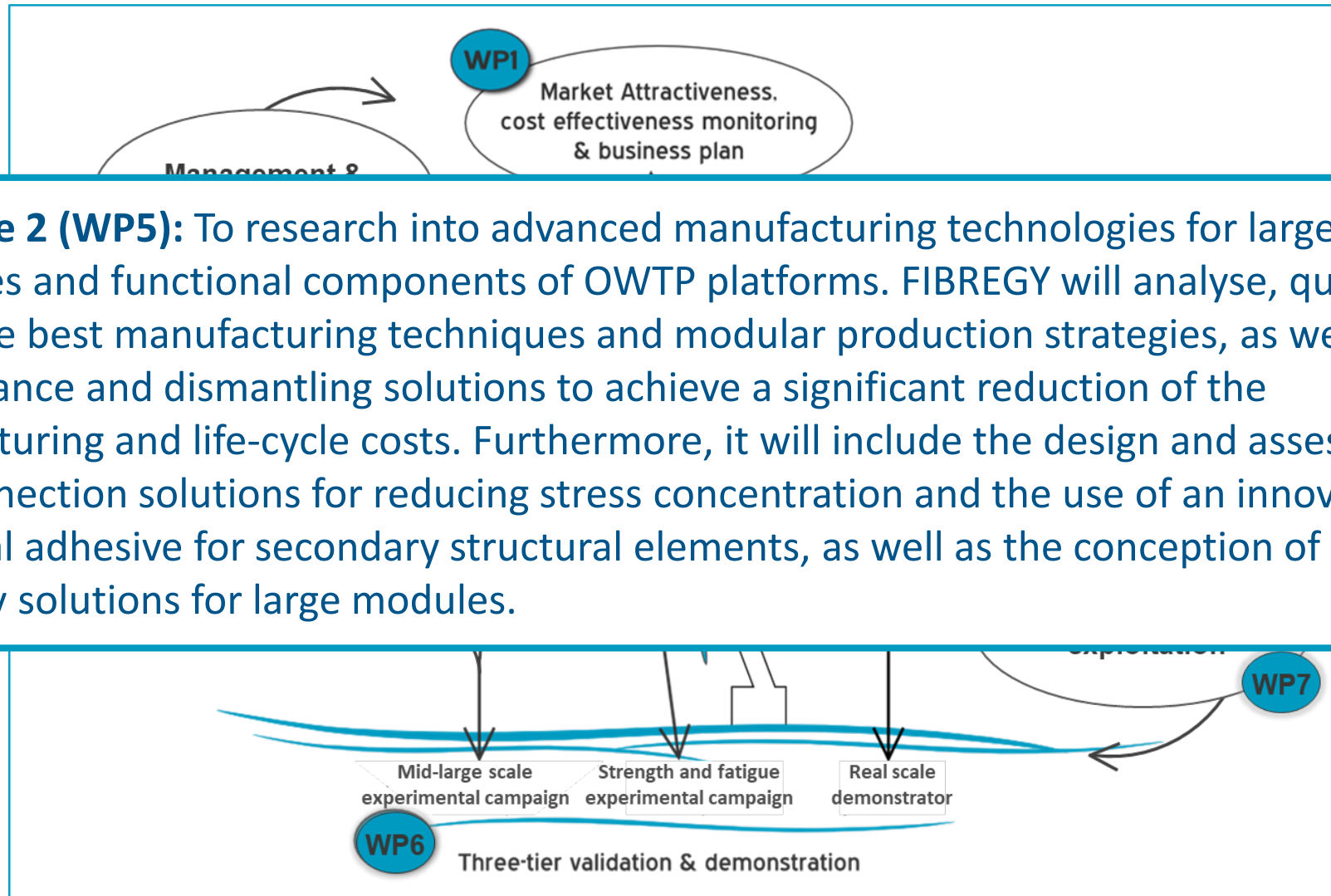

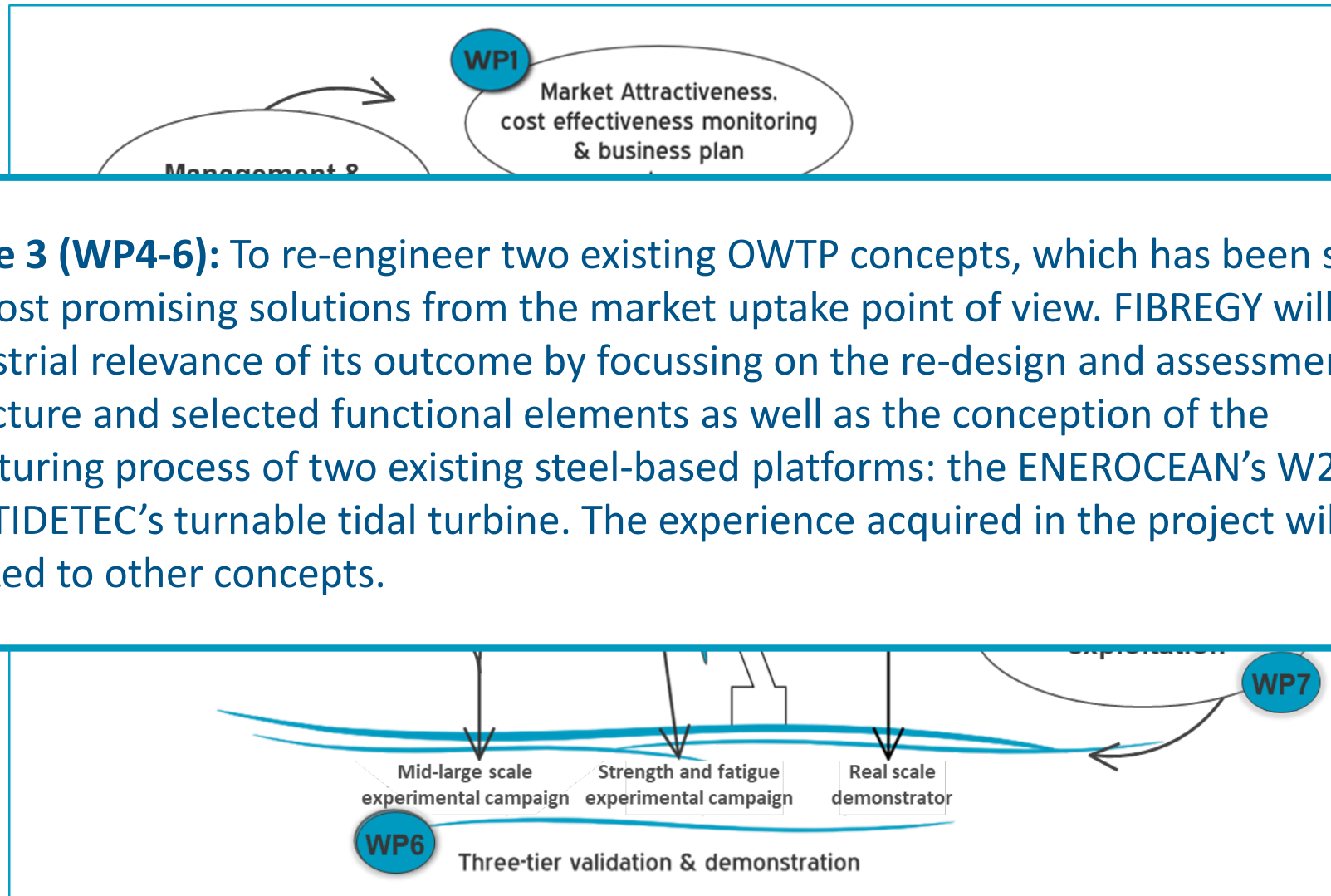

**Objective 3 (WP4-6):** To re-engineer two existing OWTP concepts, which has been selected as the most promising solutions from the market uptake point of view. FIBREGY will ensure the industrial relevance of its outcome by focussing on the re-design and assessment of the FRP structure and selected functional elements as well as the conception of the manufacturing process of two existing steel-based platforms: the ENEROCEAN's W2POWER and the TIDETEC's turnable tidal turbine. The experience acquired in the project will be generalized to other concepts.

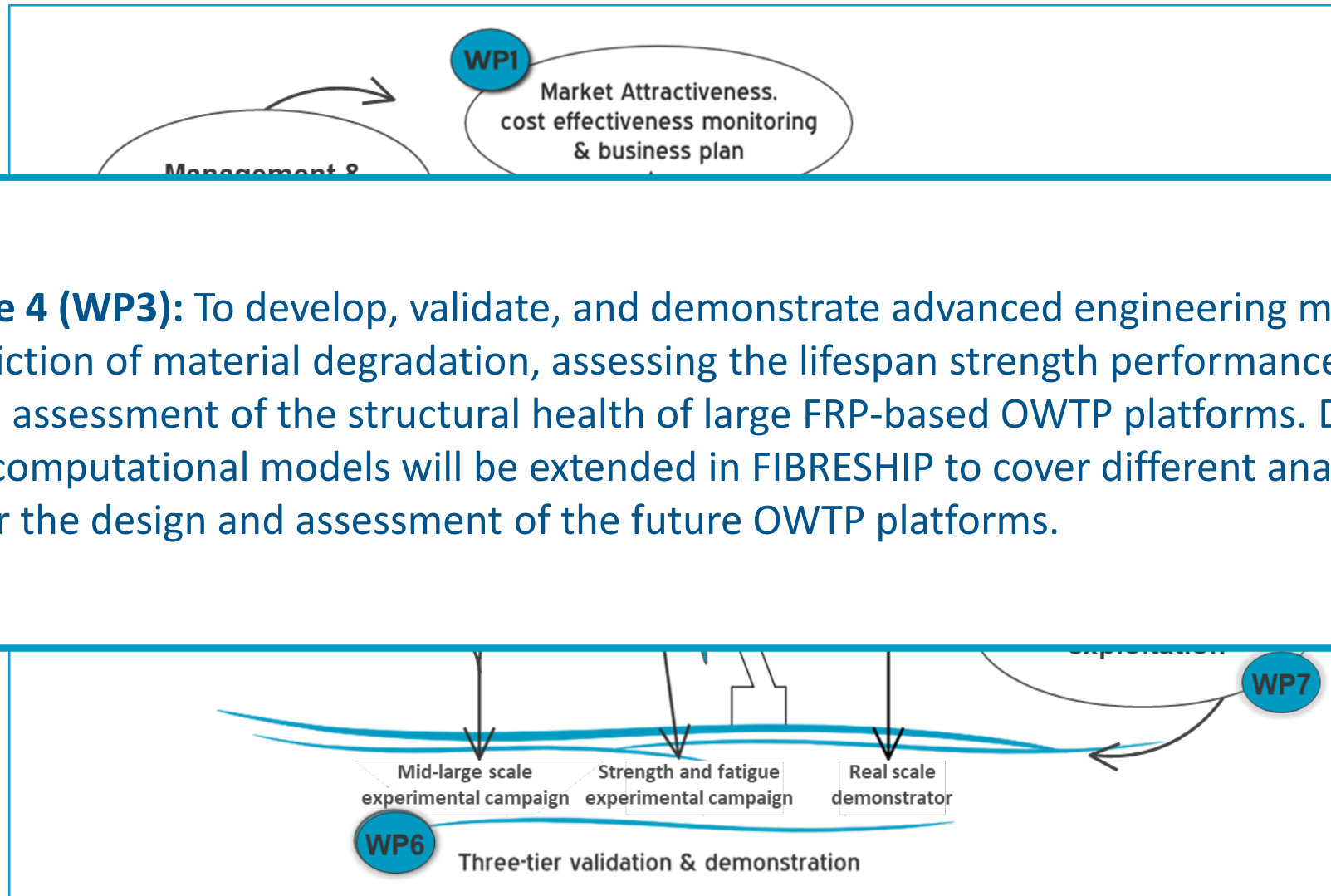



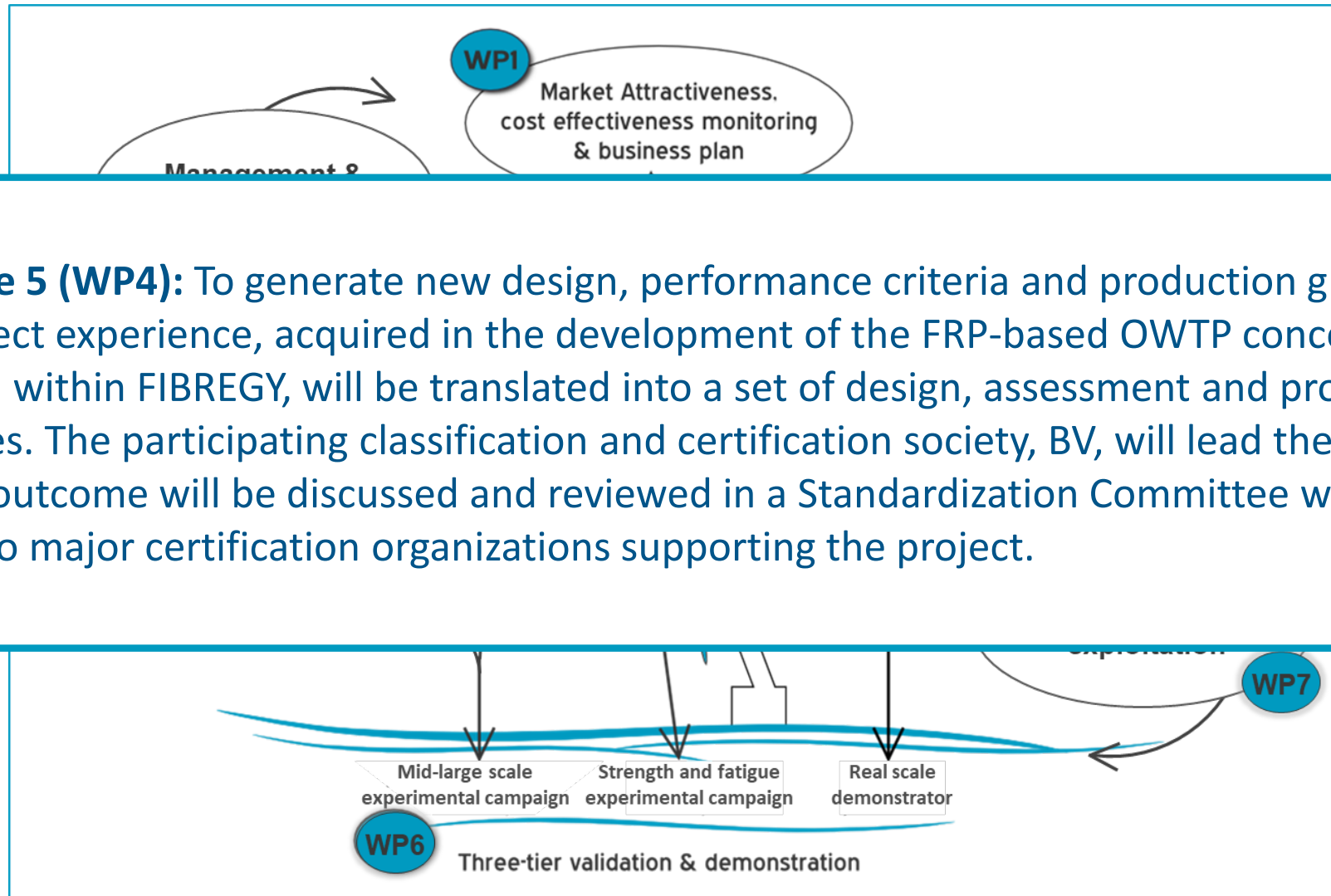

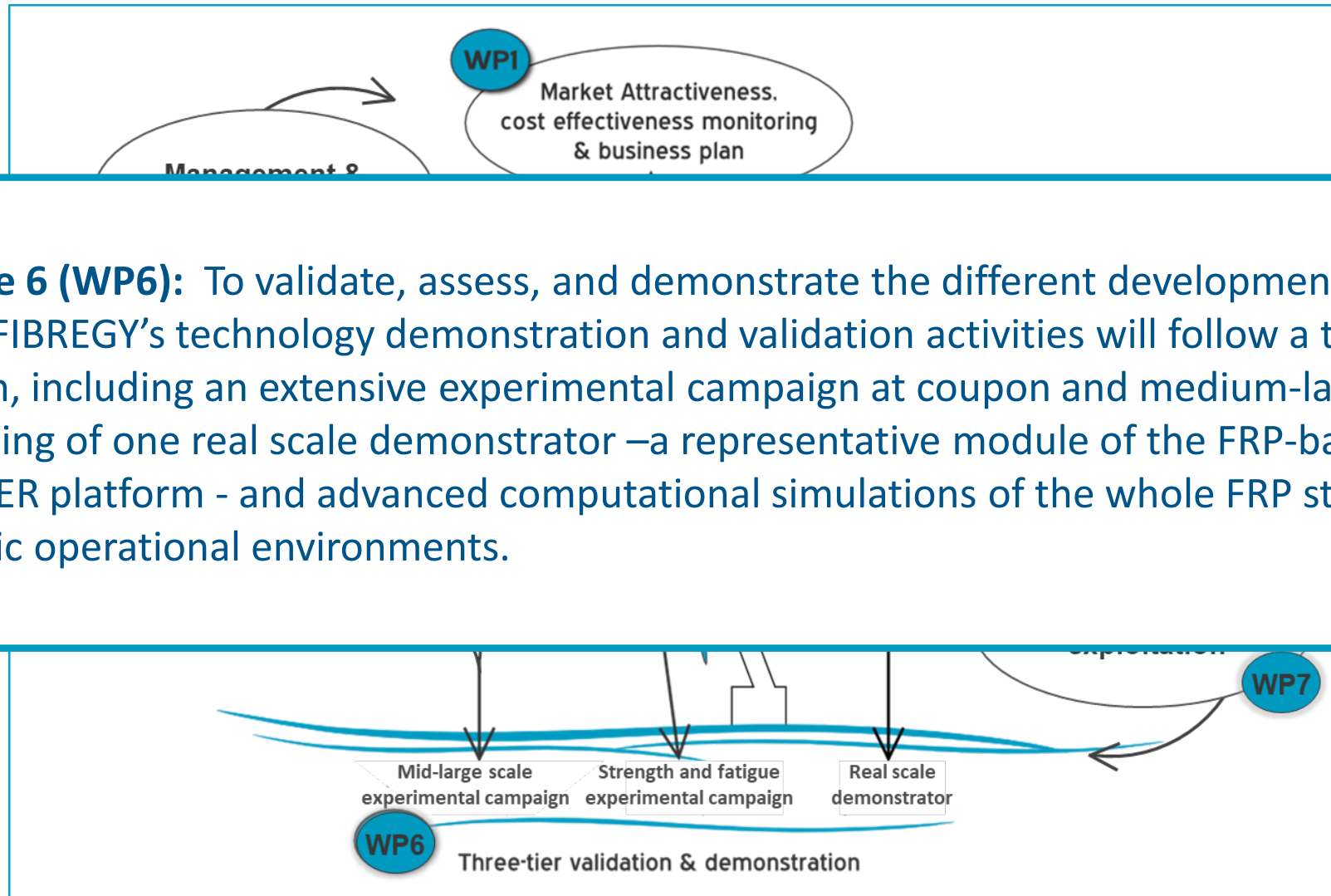

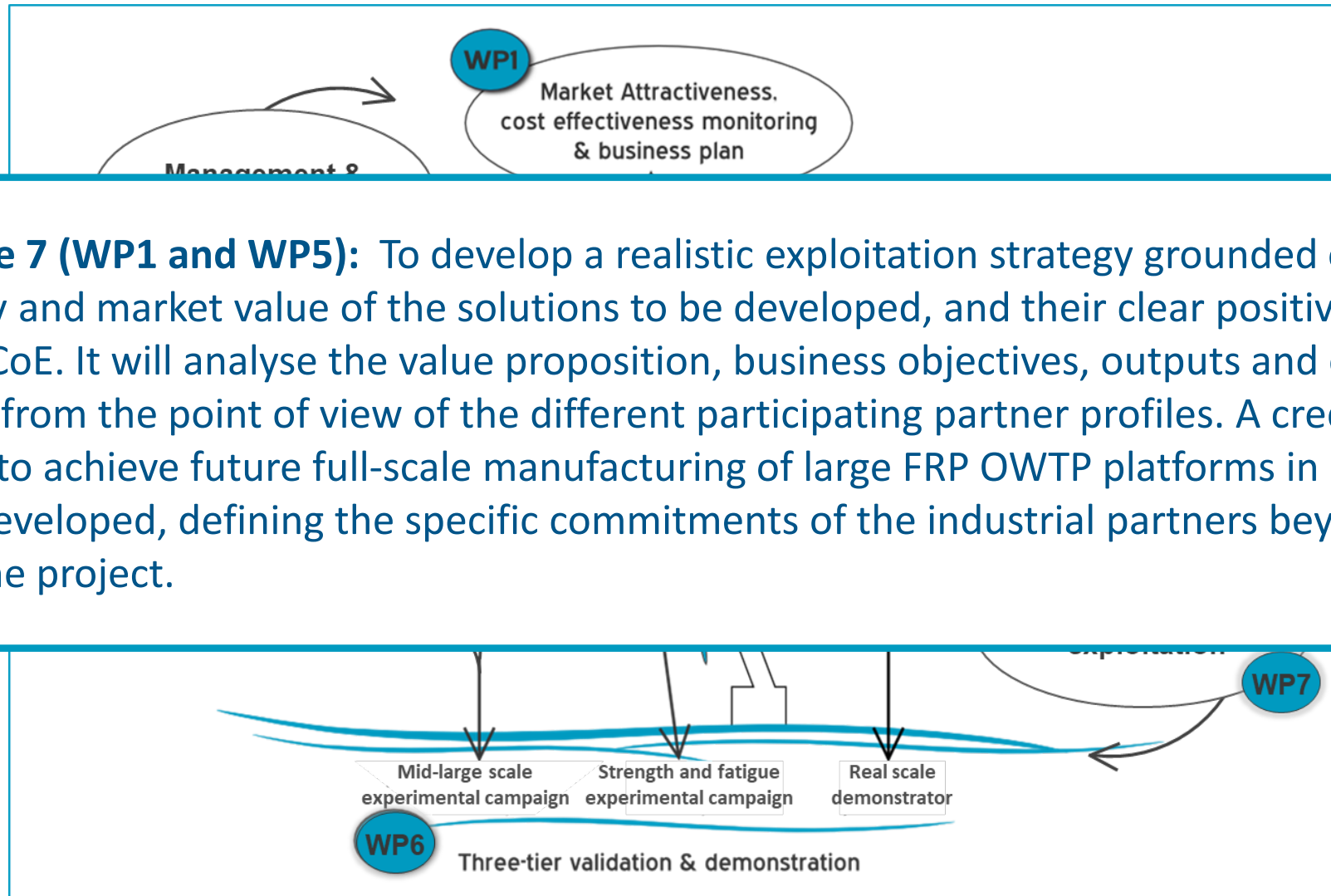

# CONTRIBUTIONS ALONG THE VALUE CHAIN

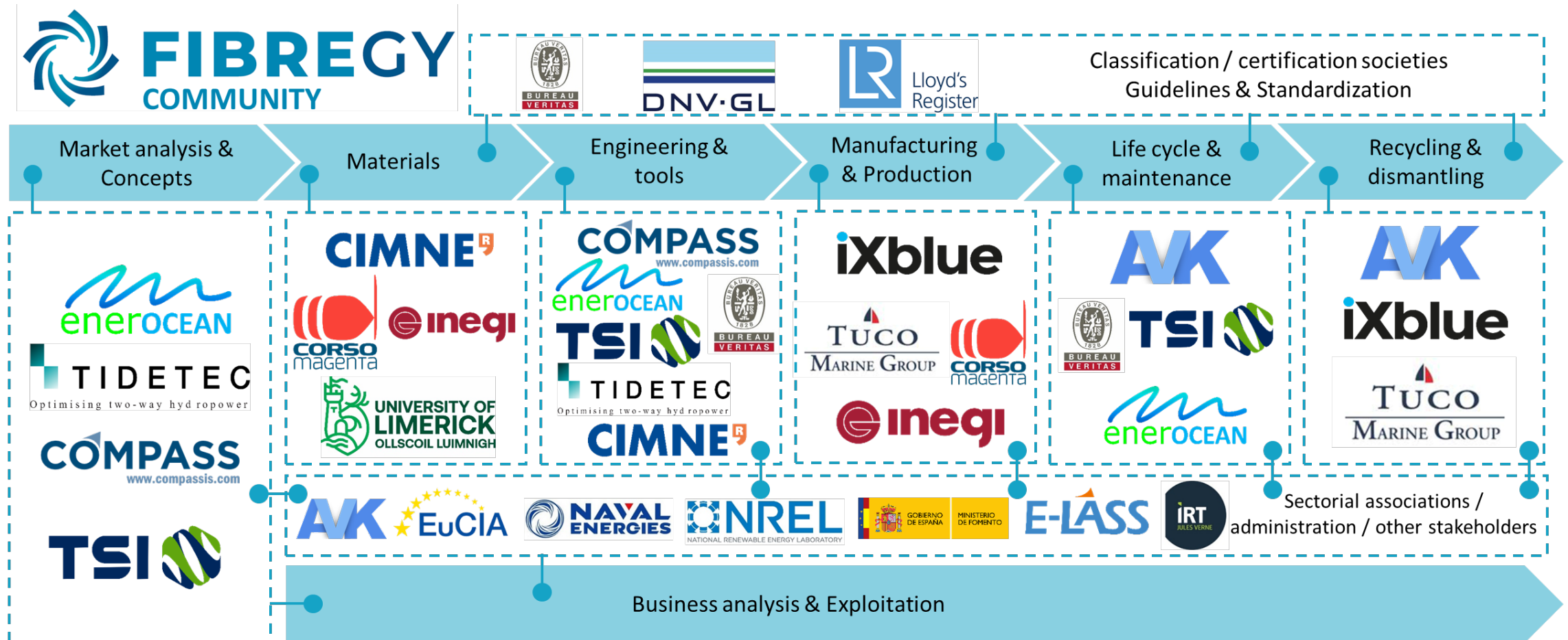

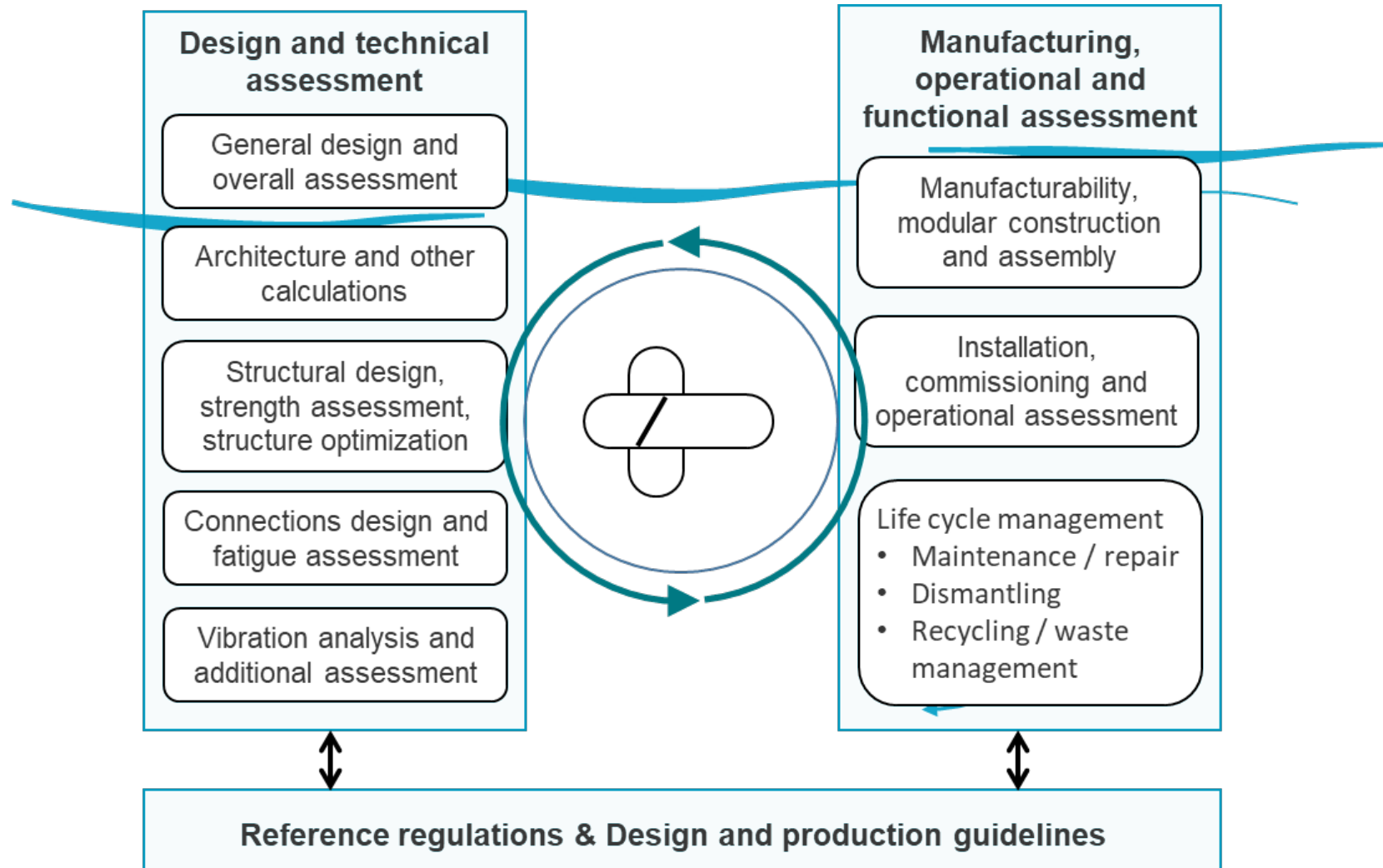

# FIBREGY's three-tier validation and demonstration plan

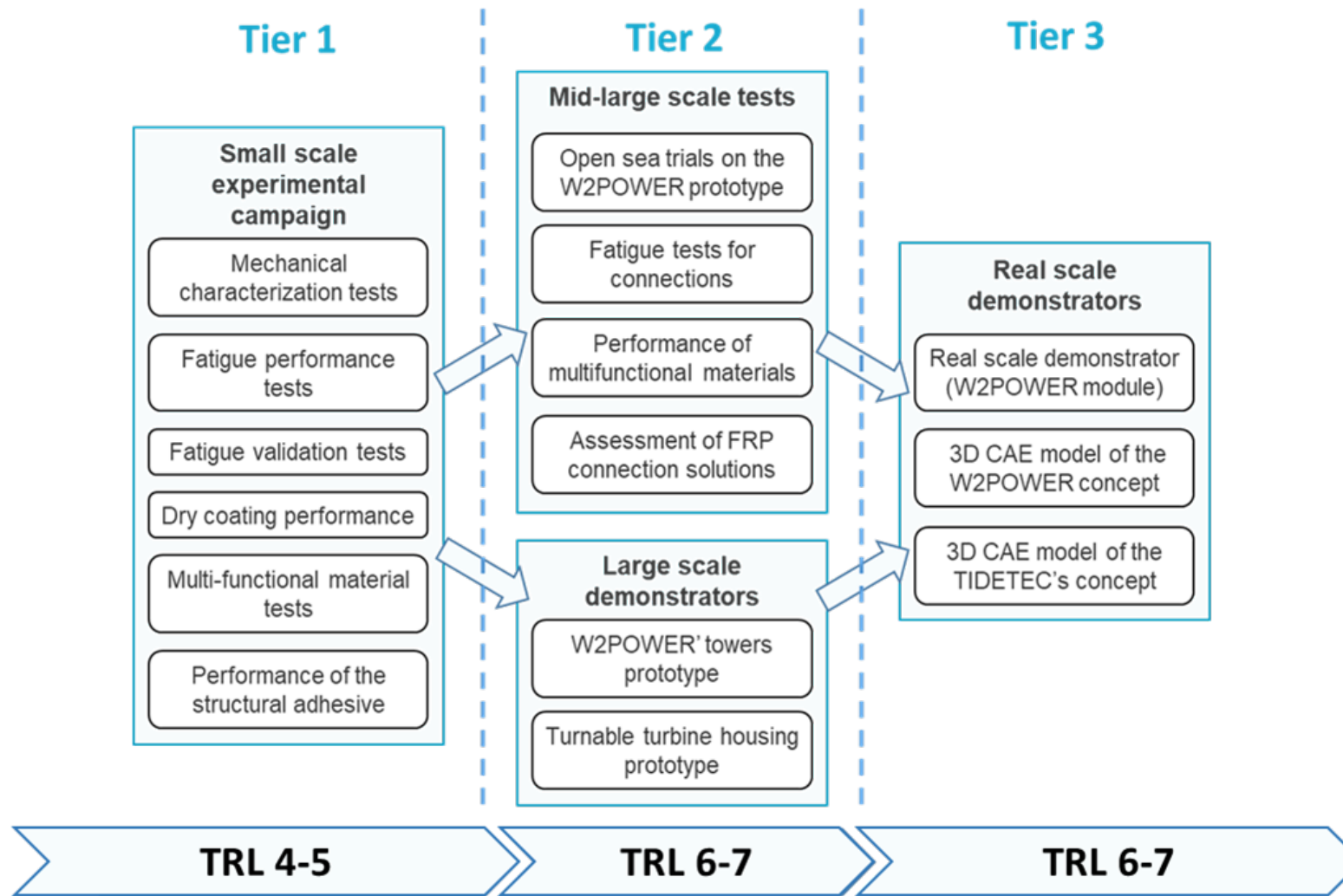

# VALIDACION AND DEMONSTRATION ON W2POWER



Large-scale 1:6 de  
Embedded SHM sys

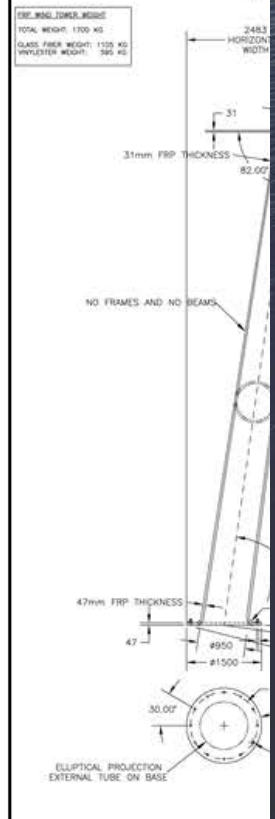

## W2Power

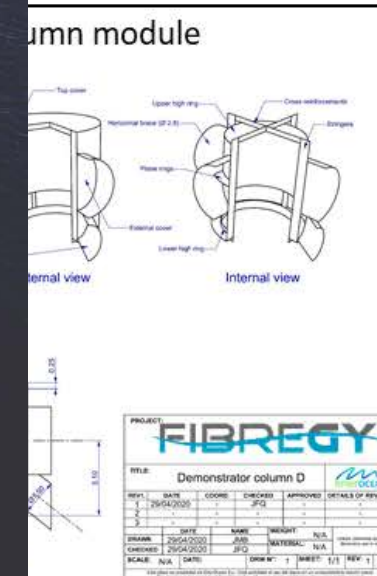

# VALIDACION AND DEMONSTRATION ON W2POWER



### Large-scale 1:6 demonstrator: Towers Embedded SHM system / open sea tests

Dwg: WIND\_TOWER\_WINDS  
 TOTAL WEIGHT: 1700 KG  
 GLASS FIBER WEIGHT: 1100 KG  
 VINYLESTER WEIGHT: 500 KG

Dwg: COMPOSITE\_LAYOUTS  
 FIBER: UNIDIRECTIONAL GLASS E  
 RESIN: VINYLESTER (50% ON MASS)  
 LAYOUT: 0°-90° / 90° - 25° / 65° - 110°  
 NON ACCEPTED FILAMENT WINDING PROCESS

QUANTITY: 2 UNITS

FIBREGY COMPASS

FRP WIND TOWER

ELLIPTICAL PROJECTION  
EXTERNAL TUBE ON BASE

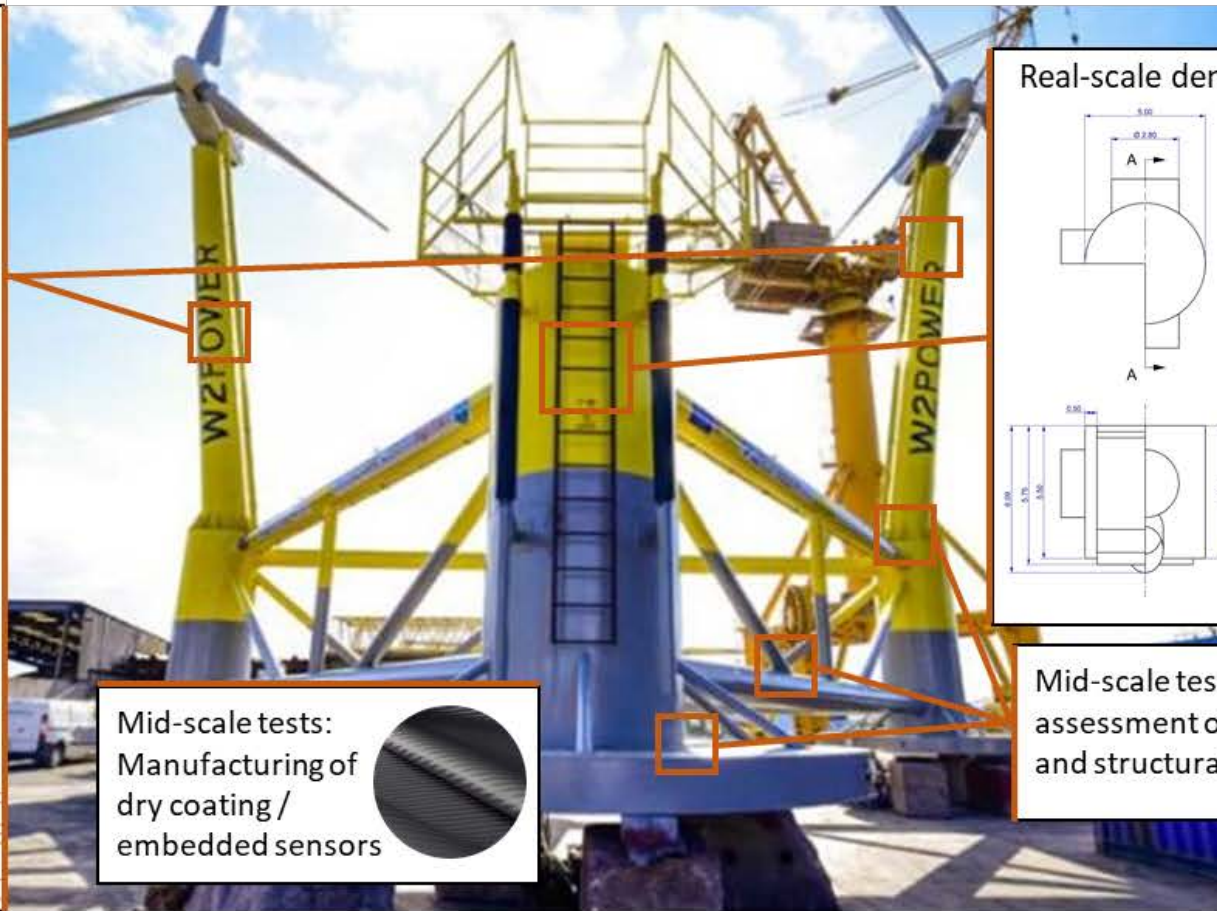

### Real-scale demonstrator: D column module

External view

Internal view

Section A-A

PROJECT: FIBREGY						
TITLE: Demonstrator column D						
REV#	DATE	CODE	CHECKED	APPROVED	DETAILS OF REVISION	
1	2024/02/05		JFO			
DESIGN	DATE	NAME	WEIGHT	N/C		
CHECKED	2024/02/05	JFO		N/A		
SCALE: N/A	DATE:	DRAWN: 1	SHEET: 1/1	REV: 1	A3	

Mid-scale tests:  
Manufacturing of  
dry coating /  
embedded sensors

Mid-scale tests: fatigue/strength  
assessment of connections/hot-spots  
and structural (reversible) adhesive



# VALIDACION AND DEMONSTRATION ON TIDETEC'S TURBINE

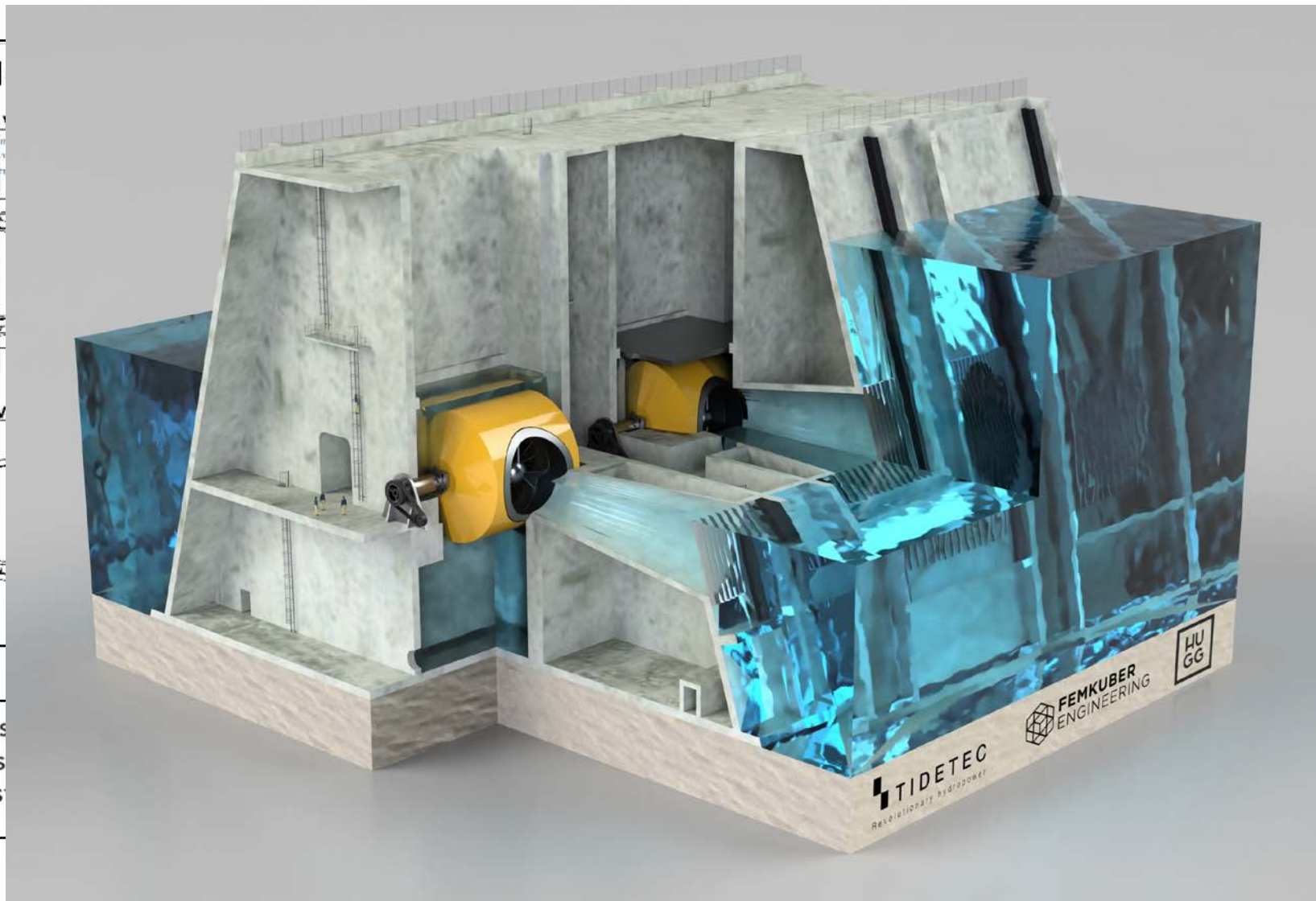
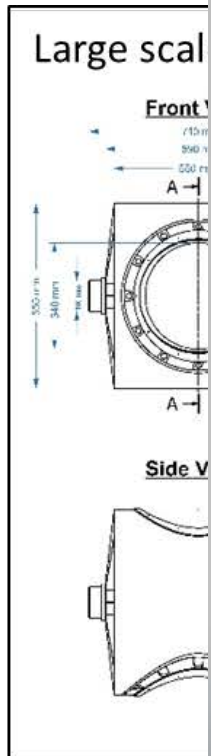

Mid-scale  
assessment  
and simulation



# VALIDACION AND DEMONSTRATION ON TIDETEC'S TURBINE

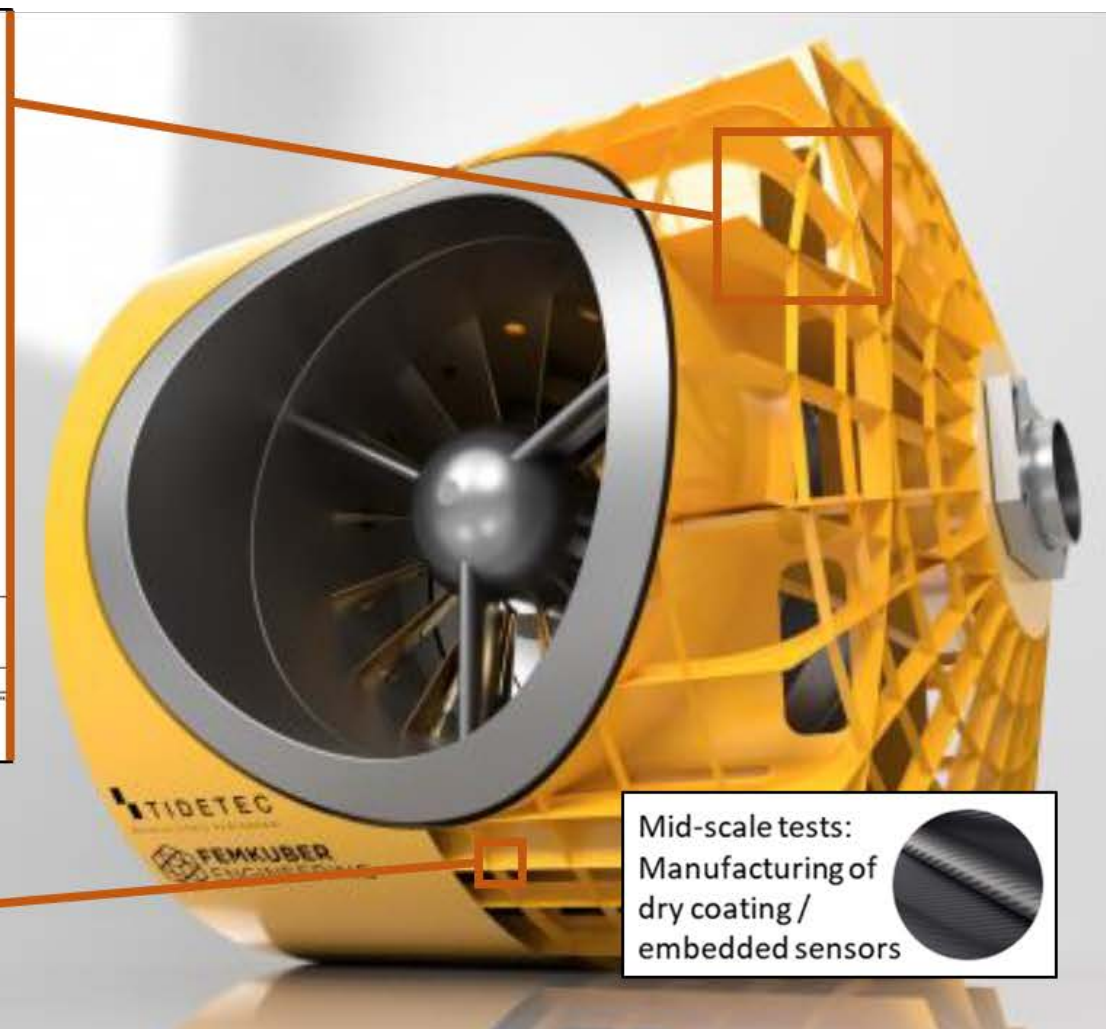
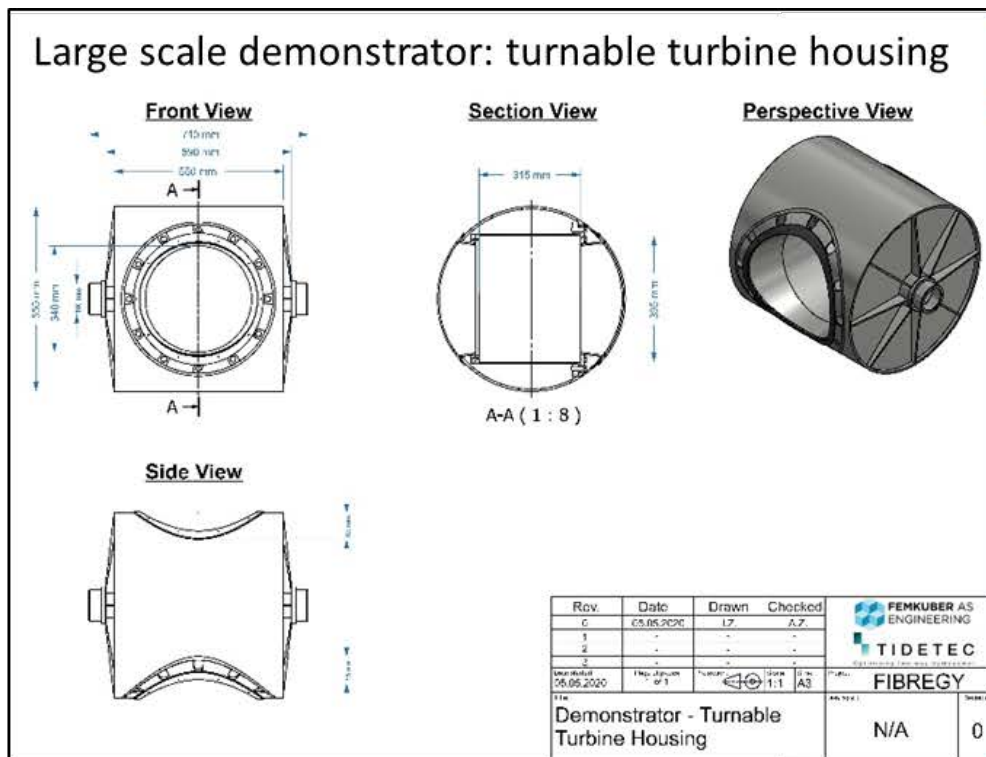

Mid-scale tests: fatigue/strength assessment of connections/hot-spots and structural (reversible) adhesive

Mid-scale tests: Manufacturing of dry coating / embedded sensors

# EXPECTED MAIN IMPACT: REDUCTION OF THE LCoE

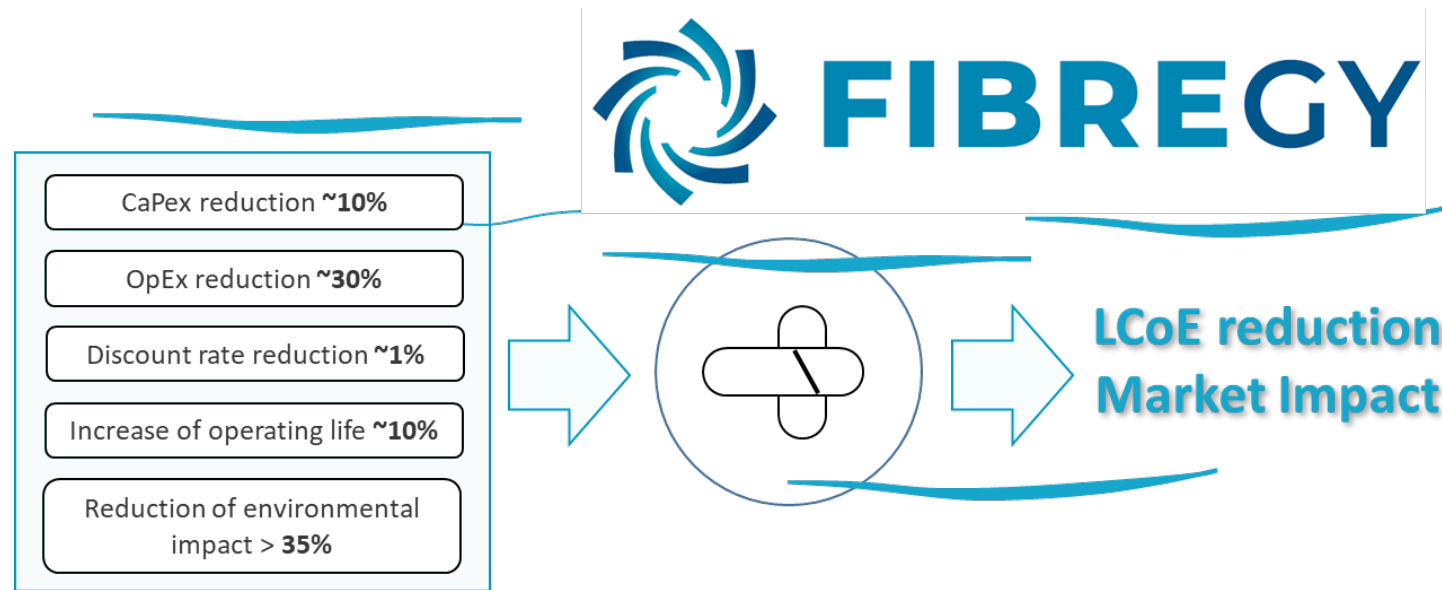

## CaPex

- Reduction of engineering, development and testing time.
- Reduction of the weight of the structure and components.
- Optimized design and manufacturing processes (modular building strategy).
- Readiness of the concepts for serial and automated production

## OpEx

- Increase of reliability.
- Increase of fatigue life.
- Immunity to corrosion.
- Improved fouling release.
- Advanced predictive maintenance.

## Discount rate

- Lower risks.
- Accelerate certification.

## Design life and operating life

- Increase of fatigue life.
- Immunity to corrosion
- Advanced predictive maintenance.

## Capacity Factor

- Improved stability.
- Improved seakeeping.
- Reduced overhauling time.

- Effective external communication of FIBREGY project is a priority, and a communication and dissemination plan for the project will be designed and executed in WP8.
- Communication and dissemination tools will include: website, leaflets, videos, newsletters, social networks profiles, open access repositories (<https://www.scipedia.com/institution/fibregy>), etc.
- A total of five main open events have been planned during the project execution:
  - Two Information days open to the public (+ specific workshops addressed to the Advisory Board's members): 1 within the first 12 months and 1 within the first 18 months.:
  - Two open-door Industrial days:: One in Madrid or Las Palmas (Spain) within the last 12 months of the project to present the W2POWER's open sea trials and one within the last 6 months of the project to show the demonstrator in La Ciotat (France). .
  - A specific session to present the outcome of the project will be organized at the International Conference of Computational Methods in Marine Engineering (MARINE).



**FIBREGY**

Contact: [julio@cimne.upc.edu](mailto:julio@cimne.upc.edu)