

AN ALTERNATIVE APPROACH FOR INELASTIC STATIC ISOGEOMETRIC ANALYSIS AND 3D DESIGN WITH ADVANCED SPLINE TECHNIQUES WITH GEOMISO TNL: A NEW HYBRID CLOUD-BASED CAD/CAE SOFTWARE

PANAGIOTIS L. KARAKITSIOS^{1*}, PANAGIOTIS F. KOLIOS², ATHANASIOS I.
LEONTARIS³ AND GEORGIOS I. KARAIKOS⁴

¹ Geomiso Company
Themistokleous 19, Farsala
pkarakitsios@geomiso.com, <https://www.geomiso.com>

² Geomiso Company
Themistokleous 19, Farsala
pkolios@geomiso.com, <https://www.geomiso.com>

³ Geomiso Company
Themistokleous 19, Farsala
aleontaris@geomiso.com, <https://www.geomiso.com>

⁴ Geomiso Company
Themistokleous 19, Farsala
gkaraiskos@geomiso.com, <https://www.geomiso.com>

Key words: Isogeometric Analysis, Finite Element Analysis, T-splines, NURBS, Material Nonlinearity, Cloud-based Software

Abstract. *The recently developed cloud-based platform www.geomiso.cloud is introduced to help engineers and industries make effective use of inelastic static isogeometric analysis and design with advanced spline techniques. The new Geomiso TNL software combines IGA and cloud computing, one of the fastest growing fields in IT industry. Cloud-based IGA represents the future of product engineering, soon to become an industry standard. This program fully integrates the industrial design with its computational real-time testing, while it is seen to handle demanding inelastic applications in structural mechanics remarkably well, as the numerical examples exhibit significantly improved accuracy with shortened computational time. It is argued that Geomiso TNL is a new, more efficient, alternative to FEA software packages. This is the first time ever such a cloud-based program has been developed.*



Co-financed by Greece and the European Union

1 INTRODUCTION

In this paper, we introduce a new, both on-premises and cloud-based software solution for inelastic static isogeometric analysis (IGA) and 3D design of sophisticated multi-patch structures with NURBS and T-splines. IGA is a powerful generalization of the traditional finite element analysis (FEA). IGA, in combination with material nonlinearity, has attracted increasing attention, as a result of the industrial need for high product quality, coupled with increasingly stringent safety. The recently developed Geomiso TNL software satisfies the rising industrial need for technical software of fully integrated Computer-Aided Design (CAD)/ Computer-Aided Engineering (CAE) nature, as it facilitates the geometry modeling within analysis and offers superior quality numerical results in various applications. This new solution empowers engineers to handle multipatch structures, efficiently test performance and optimize durability of their products otherwise very challenging due to complex loading, geometries, or material properties. As it is demonstrated in this paper with several industry applications, the developed platform is seen to handle these situations remarkably well.

Geomiso TNL directly utilizes the CAD file in its solver to perform a structural analysis without any intermediate steps of geometry clean-up or further mesh generation by using the same shape functions, namely splines, for both describing the domain geometry and building the numerical approximation of the solution. Thus, it maintains the exact representation of the geometry at any stage of the design process and eliminates geometric errors. This hybrid software provides parameterized geometries in the design, while its modern graphical user interface offers an innovative way to preserve the exact geometry at all refinement levels. Modern T-splines can accurately represent any geometry with their local refinement properties and overcome limitations inherent to NURBS, like the tensor-product topological structure, by ensuring higher-order continuity across patches, while in practical circumstances, it is often necessary to describe domains with multiple patches, especially them with parts in which different material or physical models are to be used. Geomiso TNL provides an innovative way to merge geometric design with mesh generation into a single procedure by creating, with its hybrid user interface, 3D models as tensor product grids.

Applications to inelastic problems are demonstrated with a comparison between Geomiso TNL and FEA programs. We compare the accuracy of the numerical results and the computational cost for real world and industrial applications arising in structural mechanics, while we conduct parametric investigations on the effects of the number of patches, elements, control points, and polynomial order of the basis. This viable alternative to finite element programs represents major improvements, as higher accuracy, robustness, and stability level is accomplished with considerably shortened computational cost.

The paper is structured as follows. In Section 2 we exhibit an overview on inelastic static isogeometric analysis with NURBS and T-splines, while connection between patches and material nonlinearity are discussed. Section 3 refers to the cloud-based platform, focusing on architecture, MVC model, security system, and the ability of creating parameterized geometries in cloud. Section 4 introduces the workspace of the Geomiso TNL software with sample industry applications. A comparison between Geomiso TNL, FEA programs and exact solution is made for typical examples in Section 5, while conclusions are drawn in Section 6.



Co-financed by Greece and the European Union

2 A BRIEF OVERVIEW ON INELASTIC STATIC ISOGEOMETRIC ANALYSIS

Isogeometric analysis is a new computational approach that has come to unify the fields of CAD and FEA. It was introduced by Hughes et al. [1] and since then it has attracted a lot of attention for solving boundary value problems as a result of using the same shape functions, means splines, functions commonly used in CAD, for both describing the domain geometry and building the numerical approximation of the solution. It directly employs spline geometry in the FEA application, which eliminates the geometric errors, while there is no need of repeating the geometry design for refinement purposes [2]. Popular NURBS and sophisticated T-splines are proved suitable shape functions and a mighty tool for isogeometric analysis [3]. Inelastic IGA can accurately describe the plastic deformation. It is worth mentioning that IGA, with its high-order basis functions, can greatly alleviate the phenomenon of self-locking, which is generally an unavoidable problem in low-order FEA.

2.1 NURBS

NURBS were until lately the main shape functions used in isogeometric analysis [1]. They have been a mainstay of geometric design for many years due to their flexibility and precision, as they can exactly construct any conic section. IGA has brought them into the setting of analysis, leading to more accurate results in comparison with standard finite elements based on Lagrange polynomials [1]. Parameter space is important as all calculations take place in it, while index space plays an auxiliary role.

NURBS geometries inherit properties, such as partition of unity, non-negativity, boundary-curve interpolation, continuity, and compact support for their basis functions. Due to their higher inter-element continuity, the overlapping is greater in comparison with polynomial shape functions in FEA. Regularity -1 indicates discontinuity, while regularity 0 is the minimum continuity for interior knots [2]. On the contrary to shape functions in FEA, basis functions in IGA are not interpolatory. NURBS are built from B-splines. Unlike in FEA, the B-spline parameter space is local to patches rather than elements. An element is defined in the physical mesh by the patch and the respective knot spans.

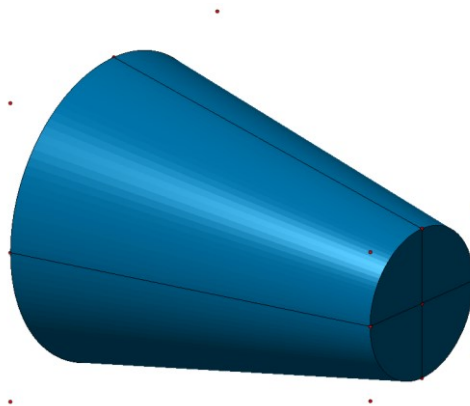

Figure 1: The control net and NURBS mesh for an industrial product, designed in Geomiso TNL. Control points are shown in red, while knot lines in black.

2.2 Connection between patches

In geometry modeling, parts of a product are modeled separately using a single patch. The discretized NURBS model is decomposed into patches, subdomains with the same material and geometry type. Each parent patch may contain subsidiary patches, consisted of knot spans, where C^{-1} or C^0 continuity is attained across their interfaces. The patches should match geometrically and parametrically on the internal faces where they meet. The discretization for the geometry of each patch should be compatible, meaning that mappings and parameterizations on the adjoining patch faces should be identical. Each control point on a face is in one-to-one correspondence with a control point from the adjoining face, meaning that the knot vectors should be matched, likewise for the control variables of the solution. A serious problem inherent in NURBS is that it is mathematically impossible for a trimmed NURBS to accurately represent the intersection of two NURBS surfaces without introducing gaps in the model. This problem is even more complicated in the case of NURBS solids. Control meshes can be severely distorted and still result in accurate stresses and full convergence rates in useful physical meshes. To make the assembly of the stiffness matrices and force vectors as simple as possible, the connectivity array will identify the respective local control variables on each face with a single control variable in the global array. By identifying them as a single entity for analysis purposes, we decrease the total amount of work. Identifying two control points at the same location in physical space as being a single entity is fairly trivial.

Patch is a subdomain, within which element types and material models are assumed to be uniform. It is a rectangle in the parameter space for 2D topologies and a cuboid for 3D, while it is decomposed into knot spans. Specifically, images of rectangular meshes in the parent domain, which mapped into the actual geometry, are defined as patches. The index of a patch uniquely identifies each knot and discriminates it among knots with multiplicity greater than one. A mesh of a NURBS patch is defined as the full tensor product of the respective knot vectors. In almost all practical circumstances to represent real world geometries and industrial applications, it will be necessary to describe them with multiple NURBS patches.

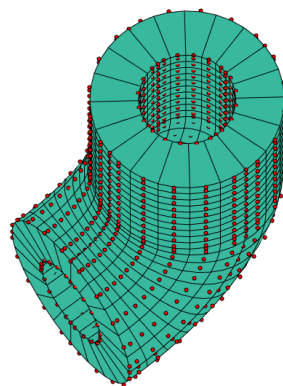

Figure 2: A multi-patch industrial product designed in Geomiso TNL, using multiple NURBS patches. Control points are shown in red. Complex, multiply connected domains, can frequently be handled quite simply by using multiple patches, while the tensor product structure of a single patch makes their representation poorly suited.

2.3 T-splines

T-splines extend NURBS to permit local refinement and coarsening, while they are very robust in their ability to efficiently sew together adjacent patches. They were introduced in 2008 as a more efficient alternative that inherits all the basic properties of NURBS and exhibits more design capabilities, like watertightness, but also sophisticated implementation, that allows better handling more complex geometries, especially when the model is irregular with hole features, and permits local refinement ensuring higher-order continuity and smoothness across patches [3]. It is not unlikely that T-splines can represent complicated shapes with only one single T-mesh. T-splines allow us to build spaces that are complete up to a desired degree, as smooth as an equivalent NURBS basis, and capable of being locally refined, while keeping the original geometry and parameterization unchanged [3]. This generalization of NURBS defined by a grid of control points, where a row can terminate without traversing the entire surface. Index space plays an important role, where junctions, anchors, local knot vectors, and elements are defined, while parameter space is auxiliary. Cartesian space represents the real geometry. Index space of a T-mesh is a rectangular tiling of a region in \mathbb{R}^2 such that each edge of every rectangle has positive integer value and vertices connecting three edges, referred to as T-junctions. Each anchor will be used to infer local knot vectors from a global structure, T-mesh, that encodes a topology and parameterization for the entire T-spline object. Each blending function has its own local knot vector. A line of decreased continuity does not necessarily propagate throughout the domain and thus T-splines may have different smoothness within a T-mesh [3].

The local T-spline construction warrants closer consideration, particularly as it bears on quadrature. The available T-junctions are limited in order the T-mesh to be analysis suitable and only T and cross junctions are accepted. The continuity in physical space follows directly from that of its blending functions in parameter space. The continuity of the blending functions is determined from their local knot vectors, while they influence the quadrature, therefore continuity reduction lines/faces in T-spline surfaces/volumes are necessary. These requirements of using T-splines in IGA are not met in the design process, for which there is no restriction for the junction type, means L, I and point junctions are allowed, as the linear independence of blending functions is not a requirement [3].

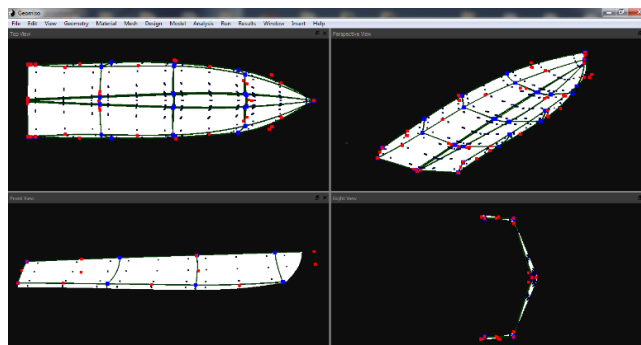

Figure 3: A T-mesh designed in Geomiso TNL, with control points in red and knots in blue. Cubic T-splines can accurately design any geometry and make the problematic and often impossible merging of patches feasible.

2.4 Material Nonlinearity in IGA

This paper focuses on the advantages of IGA in describing nonlinear behavior of materials, which is commonplace in many applications, such as metal forming, and vehicle crash test. Material nonlinearity represents the case when the constitutive law, means the stress-strain relation, is not linear. Once yield occurs, the material will deform plastically. The constitutive law provides the mathematical relationships that describe the material and govern the nonlinear analysis. A fundamental observation comparing elastic and inelastic analysis is that in elastic solutions the total stress can be evaluated from the total strain alone, whereas in inelastic response calculations the total stress also depends on the stress and strain history [4].

To describe a particular case of nonlinear material behavior in solid mechanics, a suitable model must be adopted. The nonlinear nature of a structural analysis problem emerges from the relationship between the applied external loads and the displacements, which are no longer analogous. This nonlinearity arises from either the geometry of the structure, where large deformations impose the equilibrium equations to be solved in the deformed shape, or the material itself, in case of inelastic materials. In each case, the stiffness matrix can be expressed as a function of the displacements; $\mathbf{K}=f(\mathbf{u})$. Nonlinear problems in mechanics are solved with incremental iterative algorithms based on the Newton-Raphson Method, such as Force Control Algorithm, in which the external load \mathbf{P} is applied directly with load increments $\Delta\mathbf{P}$, or Displacement Control Algorithm, in which an effective load is applied in such a way, so that a specific degree of freedom acquires constant displacement increment.

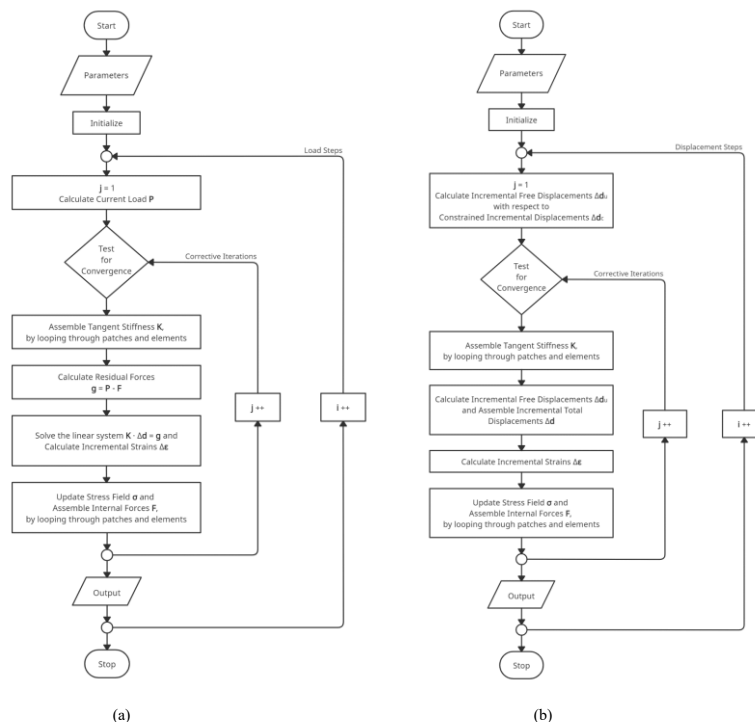

Figure 4: (a) Force Control Algorithm flow chart, combined with the Full Newton-Raphson method. (b) Displacement Control Algorithm flow chart, combined with the Full Newton-Raphson method.

3 CLOUD-BASED SIMULATION PLATFORM

3.1 Cloud architecture

In this paper we introduce the world’s first cloud-based simulation platform for isogeometric analysis www.geomiso.cloud that enables users to execute simulation experiments without the need for dedicated hardware. This platform has shown its potential for being a viable option to be used for cloud-based modeling and simulations for industry applications. The Geomiso TNL software enables engineers to test, validate, and optimize their products’ durability and performance, through IGA, via a standard web browser, more efficiently and more cost-effectively. Its simulation services allow engineers to move their simulations completely to a cloud-based solution.

By harnessing the power of the cloud for simulation, Geomiso TNL is accessible from a standard cloud-browser and from any computer, eliminating the hurdles that accompany traditional simulation tools, such as high installation costs, and deployment of high-performance computing hardware. Engineers don’t need to install any software on their computer, they just create an account on the website www.geomiso.cloud and use Geomiso TNL online. It allows users to conveniently access computing resources as pay-per-use services. The cloud version, easily accessible to every engineer, serves as an entry point for those who wish to get acquainted with IGA, while it can deliver simulations with a great number of active simulation entities, for which the workload is extensive. Workstation computers have only limited capabilities of delivering results for large-scale simulations. This leads to the problem that many engineers must either reduce the scope of their experiments or fail to execute as many experiments as they would like in a given time frame. This software helps researchers concentrate on particular design issues without considering the low-level details of cloud infrastructures. It also enables a modeler to repeatedly perform simulations and to conduct a series of simulation experiments in a quick and easy manner.

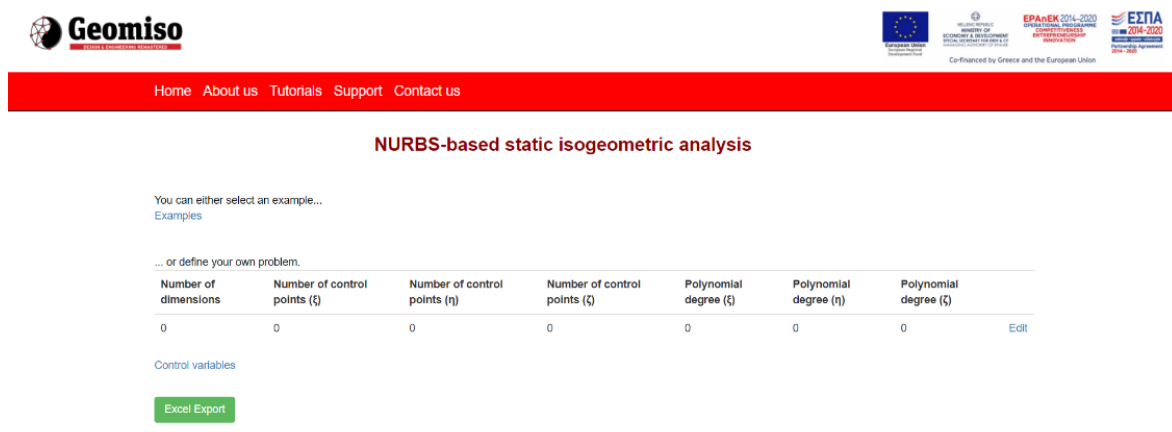

Figure 5: The world’s first cloud-based simulation platform for IGA, www.geomiso.cloud. This online software solution can design and analyze structures, and products, with demanding loading, geometries, or material properties in a cloud environment. As soon as the simulation is complete, users can access the results on the platform or download them locally.



Cloud-based systems are constantly evolving, with greater security requirements than traditional ones, as many IT experts have proposed a comprehensive protocol for cloud computing topics. Thus, it is necessary to evaluate performance and security risks that are inherent part of cloud computing, as the users are worried about security problems and cost related issues that exist with the prevalent implementation of cloud computing. Cloud security consists of a set of policies, controls, procedures, and technologies that work together to protect cloud-based systems, data, and infrastructure. These security measures are configured to protect cloud data, support regulatory compliance, and protect customers privacy as well as setting authentication rules for individual users and devices. Our simulation cloud service uses secure transfer mechanisms to communicate between cloud computing nodes, the user, and the dispatch server. All input data is encrypted and a secure channel, to either a key-server or a client device (browser) of the researcher, is opened to allow reliable key exchange.

3.2 Parameterized geometries in cloud

The cloud version of the Geomiso TNL software enabled users to automatically construct parameterized geometries and analysis-suitable spline models online. Converting CAD models to analysis-suitable volumetric T-splines is fundamental for the integration, which requires one reparameterization step to generate spline models from the boundary representations. Besides, the CAD models are mostly not watertight, which need to be reparameterized with T-splines for analysis. The quality of parameterization has a great impact on the results and the efficiency. Furthermore, the convergence rate of the IGA framework is affected by the quality of the volumetric parameterization. In IGA, there are three refinement mechanisms to improve the results by increasing the number of degrees of freedom, means h-, p-, and k-refinement, which combines order elevation and knot insertion. Their common feature is that the number of control points is increased, while the geometry remains intact. Geomiso TNL combines IGA and cloud computing, which is one of the fastest growing fields in IT industry. Cloud-based IGA represents the future of product engineering, soon to become an industry standard as development teams around the world seek to manage complexity, and further drive time and costs out of design cycle and production processes.

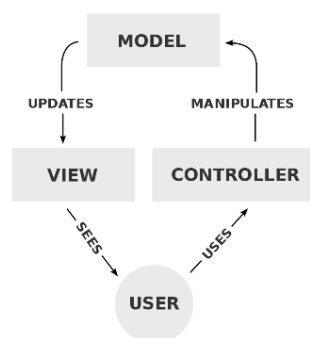

Figure 6: Interactions within one possible take on Model–View–Controller (MVC) software design pattern, which is commonly used for developing GUI, dividing the program logic into 3 interconnected parts to separate internal representations of information from the ways information is presented to and accepted from the user.

4 THE DUAL NATURE OF GEOMISO TNL

Geomiso TNL is not just a plug-in, but a recently developed both on-premises and cloud-based software with a dual CAD/CAE nature. All the geometrical, connectivity, material, quadrature, refinement, constraint, and load data, must be given as inputs to its hybrid user interface, to calculate stiffness matrix, pseudo-displacements, and displacement, strain, and stress fields. The geometrical data include control variables, polynomial orders, number of univariate basis functions and knot value vectors for each parametric direction (ξ, η, ζ).

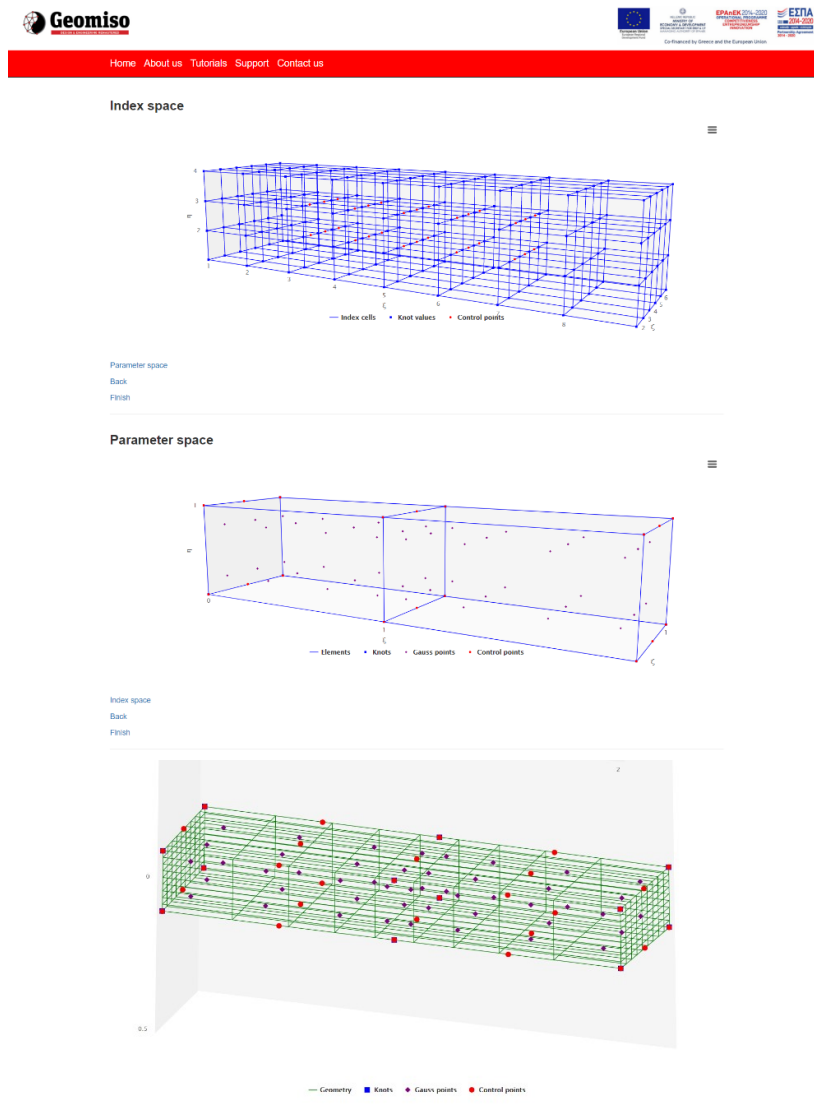

Figure 7: Index, parameter, and physical space (www.geomiso.cloud). Control points are shown in red, while knots in blue. Geomiso TNL helps all users leverage its simulation capabilities, while provides increasing speed and productivity for the entire product development process, as it merges geometric design with mesh generation into a single procedure, eliminates geometric errors, increases the accuracy of the numerical results, and significantly reduces the required computational cost, when compared with commercial FEA software packages.

5 APPLICATIONS

We present an industrial application of the Geomiso TNL software to a 3D problem in solid mechanics of a rectangular steel beam under pure bending. The numerical results, which are compared with FEA results and the exact solution, indicate that Geomiso TNL is a more efficient alternative to FEA programs. A steel ($E=200.000$ MPa, $\nu=0,3$, $f_y=500$ MPa) beam, with length 5.000 mm and rectangular cross-section 5×500 mm², under pure bending, is presented in **Figure 8**. Both edges are fixed, while on top of it, a uniform surface load is applied along thickness. Plastic hinges appear on both edges and its mid-point.

We compare the results from Geomiso TNL, means displacement d_Y and equivalent plastic strain of two reference points (edges, mid-point), with FEA results and analytical solution. We use 17 meshes (4 linear, 5 quadratic, 4 cubic, 4 quadric - $N_x M_x L$: $1 \times 1 \times 1$, $6 \times 1 \times 1$, $12 \times 2 \times 1$, $24 \times 4 \times 1$, $48 \times 8 \times 1$) for this nonlinear isogeometric analysis with Geomiso TNL.

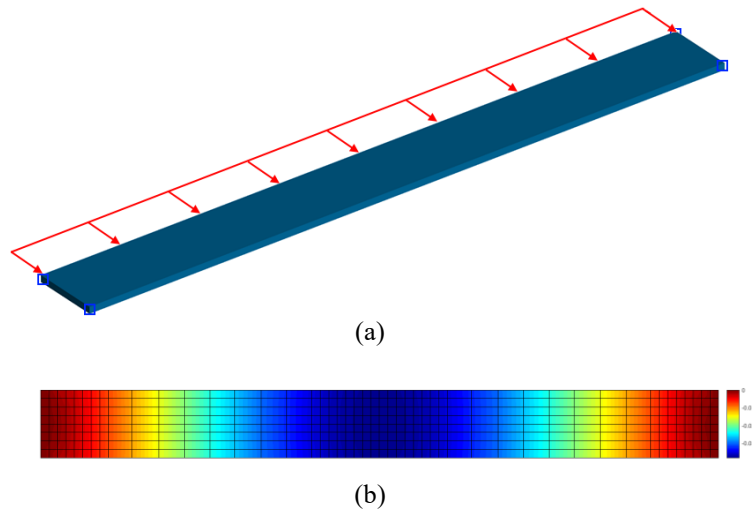

Figure 8: Steel beam under pure bending, designed in Geomiso TNL. (a) Geometry designed in Geomiso TNL. (b) Contour plot of displacements d_Y .

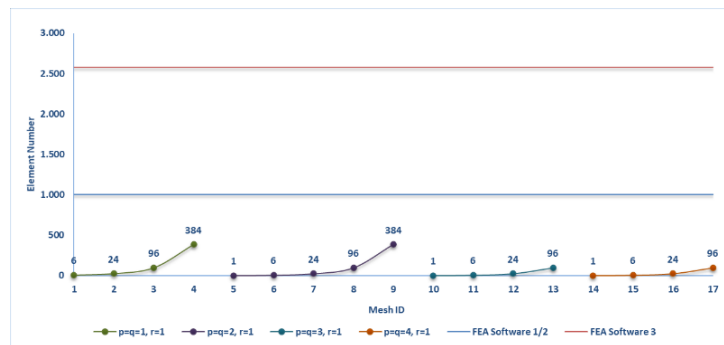

Figure 9: Geomiso TNL achieves accurate results with significantly fewer elements in comparison with FEA software. 17 meshes are used in this nonlinear isogeometric analysis with Geomiso TNL and are compared with three FEA meshes (one for each of the three commercial FEA software packages) and the analytical solution.

The surface load – displacement d_Y response is depicted in **Figure 10**, while the surface load – equivalent plastic strain curve in **Figure 11** (edges) and **Figure 12** (mid-point) respectively.

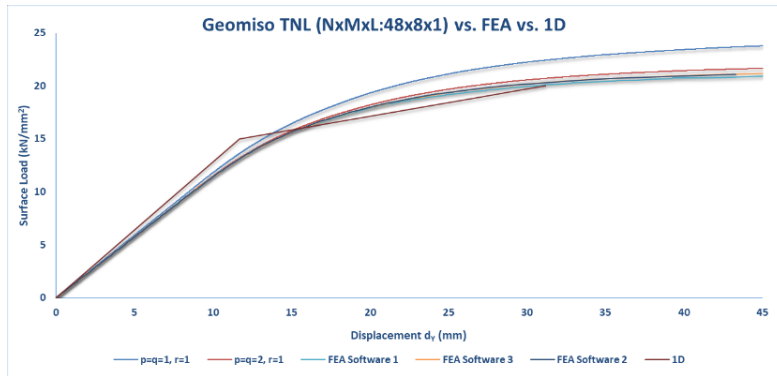

Figure 10: Displacement d_Y of the reference point (mid-point) is plotted versus the surface load. Geomiso TNL vs. FEA and exact solution (NxMxL: 48x8x1, pxqxr: 1x1x1, 2x2x1).

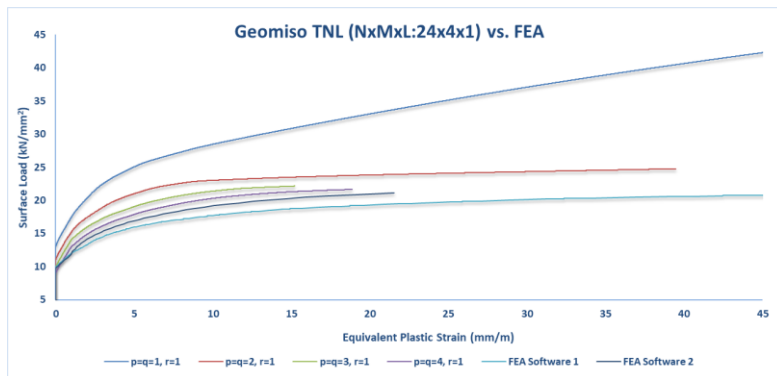

Figure 11: Equivalent plastic strain of the reference point (edges) is plotted versus the surface load. Geomiso TNL vs. FEA. (NxMxL: 24x4x1, pxqxr: 1x1x1, 2x2x1, 3x3x1, 4x4x1).

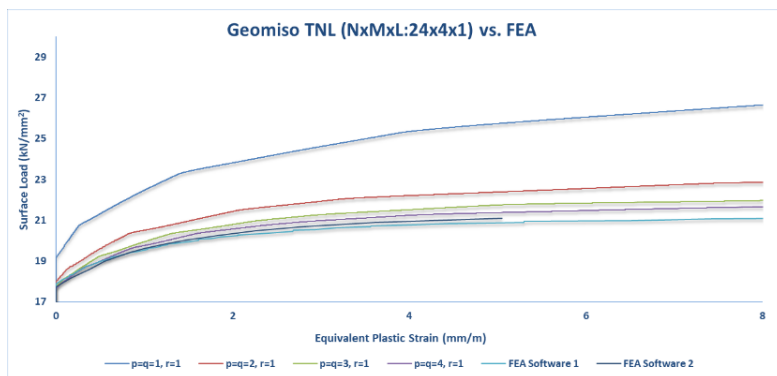

Figure 12: Equivalent plastic strain of the reference point (mid-point) is plotted versus the surface load. Geomiso TNL vs. FEA (NxMxL:24x4x1, pxqxr: 1x1x1, 2x2x1, 3x3x1, 4x4x1).

6 CONCLUSIONS

- The new Geomiso TNL software, which is the world's first cloud-based program for isogeometric analysis and design with advanced spline techniques, is considered to be a comprehensive answer to today's simulation challenges and a viable alternative to traditional finite element software packages, as it removes the barriers between design and analysis and represents major improvements, such as superior quality numerical results, robustness, stability level, cost-efficiency and instant access from a web browser.
- This hybrid software solution utilizes the CAD file in its solver to perform structural analysis without any intermediate steps of geometry clean-up or further mesh generation by using the same shape functions, namely splines, for both describing the domain geometry and building the numerical approximation of the solution. This is the first time ever such a hybrid cloud-based software has been developed.
- Applications to nonlinear problems in structural mechanics have proved successful. Superior accuracy of IGA over FEA has been shown in all applications, and indications of significantly increased robustness and stability level in analysis have been noted, with drastically shortened computational cost.

ACKNOWLEDGEMENTS

This research has been co-financed by the European Union and Greek national funds through the Operational Program Competitiveness, Entrepreneurship, and Innovation, under the call RESEARCH – CREATE – INNOVATE (project code: T1EDK-04288).



Co-financed by Greece and the European Union

REFERENCES

- [1] Hughes, T.J.R., Cottrell, J.A. and Bazilevs, Y. *Isogeometric analysis: CAD, finite elements, NURBS, exact geometry and mesh refinement*. Comput. Methods Appl. Mech. Engrg. (2005) 194:4135–4195.
- [2] Karatarakis, A., Karakitsios, P. and Papadrakakis, M. *GPU accelerated computation of the isogeometric analysis stiffness matrix*. Comput. Methods Appl. Mech. Engrg. (2014) 269:334-355.
- [3] Bazilevs, Y., Calo, V.M., Cottrell, J.A., Evans, J.A, Hughes, T.J.R., Lipton, S., Scott, M.A. and Sederberg, T.W. *Isogeometric analysis using T-splines*. Comput. Methods Appl. Mech. Engrg (2010) 199:229-263.
- [4] Elguedj, T., Bazilevs, Y., Calo, V.M. and Hughes, T.J.R. *\bar{B} and \bar{F} projection methods for nearly incompressible linear and non-linear elasticity and plasticity using higher-order NURBS elements*. Comput. Methods Appl. Mech. Engrg. (2008) 197:2732-2762.



Co-financed by Greece and the European Union